

Explosion proof and weatherproof VoIP-telephones

Ex ResistTel IP2 / IP154 **ResistTel IP2 / IP152**



Short Manual



Brand names are used with no guarantee that they may be freely employed. Almost all hardware and software designations in this manual are registered trademarks or should be treated as such.

All rights reserved. No part of this manual may be reproduced in any way (print, photocopy, microfilm or by any other means) or processed, duplicated or distributed using electronic systems without explicit approval.

Texts and illustrations have been compiled and software created with the utmost care, however errors cannot be completely ruled out. This documentation is therefore supplied under exclusion of any liability or warranty of suitability for specific purposes. FHF reserves the right to improve or modify this documentation without prior notice.

Note

Please read the operating manual carefully before installing the device.

This is only a short manual. The most important operating procedures and the mounting and installation instructions are part of this document. For the complete configuration and operating of all features the knowledge of the complete manual is necessary.

The complete manual is attached on the CD.

Please check the contents of the box for completeness.

Table of Contents

1	VoIP Telephone ResistTel IP2 / IP152 and ExResistTel IP2 / IP152.....	5
1.1	Keypad.....	5
1.2	Keypad Description	6
1.3	Display.....	7
1.3.1	Default Display.....	7
1.3.2	Menu and Listing Display	9
1.4	As-Delivered Condition	10
1.4.1	Default Version one LAN Connection with a Cable Screw Cap	10
1.4.2	Version one LAN Connection with a Female Housing Connection	10
1.4.3	Version one Switch LAN Module with two LAN Connections with Cable Screw Cap	11
1.4.4	Version one Switch LAN Module with two LAN Connections with Cable Screw Cap	11
1.5	Mounting and Installing.....	12
1.5.1	LAN-Connections.....	16
1.5.1.1	Default Version one LAN Connection with a Cable Screw Cap	16
1.5.1.2	Version one LAN Connection with a Female Housing Connection	16
1.5.1.3	Version with Switch LAN Module with two LAN Connections with Cable Screw Caps	17
1.5.1.4	Version with Switch LAN Module with two LAN Connections with two Female Housing Connections.....	17
1.5.2	External Power Supply Connection	18
1.5.3	Relay Connection	18
1.5.4	Other Terminals	19
1.5.5	Sling Holder	20
1.5.6	General.....	20
1.6	EMC-Directive.....	20
2	Operating Manual.....	21
2.1	Operating Basics	21
2.1.1	Adjusting the Volume	22
2.1.2	Do not Disturb	22
2.1.3	Different Types of Call Numbers.....	23
2.1.4	Input of Characters and Special Characters.....	23
2.2	Operating Modes	24
2.2.1	Changeover from Handset Mode to Handset Mode with Open Listening.....	24

2.2.2	Changeover from Handset Mode with Open Listening to Handset Mode.....	25
2.2.3	Changeover from Handset Mode (with or without Open Listening) to Hands Free Mode.....	25
2.2.4	Changeover from Handset Mode (with or without Open Listening) to Headset Mode.....	25
2.2.5	Changeover from Hands Free Mode to Handset Mode.....	25
2.2.6	Changeover from Hands Free Mode to Headset Mode.....	25
2.2.7	Changeover from Headset Mode to Headset Mode with Open Listening.....	25
2.2.8	Changeover from Headset Mode with Open Listening to Headset Mode.....	25
2.2.9	Changeover from Headset Mode (with or without Open Listening) to Handset Mode	26
2.2.10	Other Changeover of the Operating Mode.....	26
2.3	Call Functions	26
2.3.1	Answering Calls.....	26
2.3.2	Terminating a Call	27
2.3.3	Making Calls.....	27
2.3.3.1	Single Dialling	27
2.3.3.2	Block Dialling	28
2.3.3.2.1	Menu Parameter Input Indirect Dialling	29
2.3.3.3	Dialling during existing Connections.....	29
2.3.4	Redialling.....	29
2.3.5	Call Back.....	31
2.3.6	Muting.....	32
2.3.7	Making second Call.....	32
2.3.8	Switching.....	33
2.3.9	Transferring a Call.....	34
2.3.10	Transferring a Call directly	35
2.3.11	Initiating a Conference	35
3	Technical Data weatherproof Telephones	37
4	Notes	39

1 VoIP Telephone ResistTel IP2 / IP152 and ExResistTel IP2 / IP152



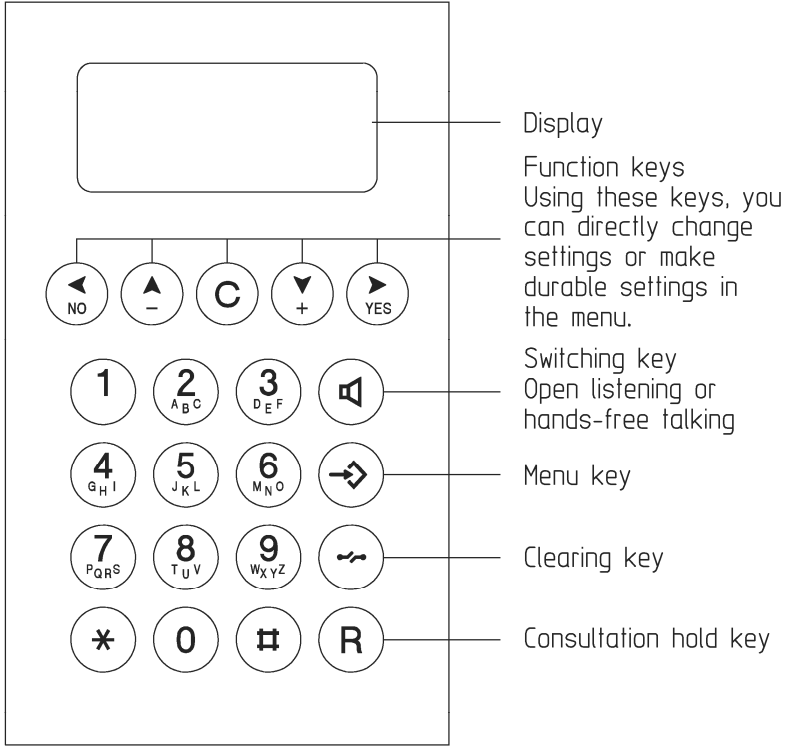









1.1 Keypad



Number keys
 These keys are used to enter call numbers and texts.

Figure 1: Keypad of the VoIP-Telephone

1.2 Keypad Description

Symbol	Description and Key Functions
	The Loudspeaker key is used to control the hands free and listening mode.
	The Menu key is used to open the main menu or to save changes.
	The Disconnect key is used to terminate calls or any menu.
 (short)	The Enquiry key is used to enable the "Hold" and "Switch" functions. In idle mode, the Enquiry key is used to call up the list of missed calls. To execute the enquiry function the Enquiry key has to be pressed short (shorter than 0.5 seconds).
 (long)	The Redial key is used to select the list of 100 phone numbers last dialled. In the menu, the redial key confirms the current selection. The phone ResistTel IP2 / IP152 has no single Redial key. To execute the redial function the Redial key has to be pressed long (longer than a second).
	Arrow keys are used for navigation in the menu and browsing in the telephone directory. The volume can only be adjusted during a call.
 (long)	The asterisk key also serves as a mute key. During a call, a longer press switches the microphone off or on.
   	Digit keys for entering phone numbers. The asterisk and hash keys have special functions. To enter asterisk and Hash the keys have to be pressed short (shorter than 0.5 seconds). To enter Mute (asterisk) and Shift (hash) the keys have to be pressed long (longer than a second). After pressing of shift the digit keys (1 – 9 and 0) become function keys. After executing a function key the shift mode is ended.
	The Clearing key is used in input mode to delete the characters left to the cursor.



Symbol	Description and Key Functions
	<p>The headset key is used to make and to end a call in the headset mode. The phone ResistTel IP2 / IP152 has no single headset key. To execute the headset key function the key  has to be pressed long (longer than a second) and then the loudspeaker key  has to be pressed. The headset key can be used only, if the headset is configured to on (see manual). This makes sense only, if a headset is connected to the phone.</p>

Table 1: Keys and Function Elements

1.3 Display

The display of the VoIP Telephone ResistTel IP2 / IP152 has 7 lines with max. 30 characters and a state line for showing information.

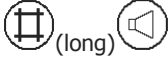
1.3.1 Default Display

The name and telephone number of the current registration is displayed in the first line.

The middle lines display special information relating to the condition.

The date, time and registration status is displayed in the last line.

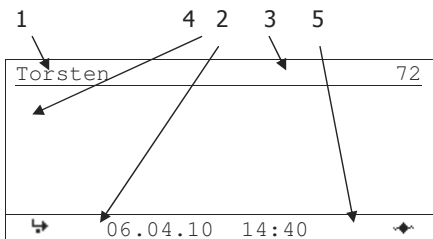

Figure 2: Default Display of the VoIP Telephone ResistTel IP2 / IP152























Position	Symbol	Description
1		Name (H.323 or SIP ID or nickname of the PBX configuration)
2		Status line; provides information on the current status of the telephone by means of the following symbols.
	06.04.10	Date
	14:00	Time
		No connection to the gatekeeper
		Connection established to the gatekeeper
		Connection established to the secondary gatekeeper
		Connection to the gatekeeper broken. (Both symbols are displayed in mutual change
		Open listening
		Hands free Mode
		Microphone switched off (symbol flashing)
		Call diversion activated
		Handset activate
		Headset active
		Telephone locked
	Calling number transmission locked	
3		Own call number (E.164)
4		Called party
		Calling party
		Unknown number/name, unresolved number
		Diverting party
		Transferring party
		Returning call
		Call pending
		Call on hold
5		Shift Mode
		Headset configured
		Audio connection of the active call is scrambled (SRTP)
	0:12	Duration of the active call

Table 2: Contents of the Default Display

1.3.2 Menu and Listing Display

The first six lines are used for the menu and listing display.

The last line is used for display of menu level, display name, scroll information and type of entry.

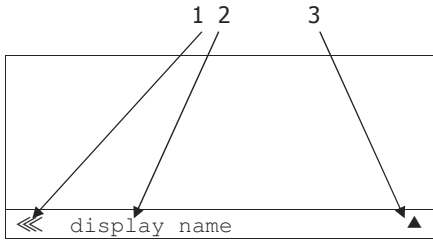

Figure 3: Menu and Listing Display of the VoIP Telephone ResistTel IP2 / IP152

Position	Symbol	Description
1		Menu or listing level 0
	<	Menu or listing level 1
	<<	Menu or listing level 2
	<<<	Menu or listing level 3
	<<<<	Menu or listing level 4 or lower
2		Display name
3	▲	Scrolling up possible
	↕	Scrolling up and down possible
	▼	Scrolling down possible
	a	Alphanumeric input
	1	Numerical input
		Choice, next level

Table 3: Contents of the Menu and Listing Display

1.4 As-Delivered Condition

The phone is available for delivery in different versions.

- Handset with armed court.
- Single LAN connection or switch LAN modul with two LAN connections with internal connection and cable screw connection or external LAN connection and plug in connection.
- Housing in black or coloured in red or blue.
- Some Sealing plugs to connect option equipment
- Optional: max. 5 cable screw caps
- Optional: relay module

Accessories (optional):

- Headset with connection cable and attachment of the bracket.
- LAN connector from Phoenix Contact, consisting of:
 - RJ sleeve housing Type VS-08-T-RJ45/IP67, Art.-Nr.: 1688696
 - Male insert RJ45, CAT5, 8-polig Type VS-08-ST-RJ45/IP67, order-no.: 1688573
- LAN female connector for cable mounting from Tycoelectronics (AMP), order-no. 116604-2
- Cable screw cap
- Sealing plugs

2 keys for torx socket screws TX20, TX30

1.4.1 Default Version one LAN Connection with a Cable Screw Cap

- 1 LAN connection internal
- Housing with 1 cable screw caps and 2 bored holes with sealing plugs at the upper side.

Box contents

The scope of the delivery includes:

- Telephone
- Printed short manual
- Manual on CD
- 1 LAN female connector for cable mounting from Tycoelectronics (AMP), order-no. 116604-2
- 2 keys for torx socket screws TX20, TX30

1.4.2 Version one LAN Connection with a Female Housing Connection

- 1 LAN connection female housing connection
- 1 LAN connection (without LAN interface) and sealing plug at the housing
- Housing with 1 bored hole with sealing plug at the upper side

Box contents

The scope of the delivery includes:

- Telephone
- Printed short manual
- Manual on CD
- 1 LAN connector from Phoenix Contact, consisting of:
 - o RJ sleeve housing Type VS-08-T-RJ45/IP67, Art.-Nr.: 1688696
 - o Male insert RJ45, CAT5, 8-polig Type VS-08-ST-RJ45/IP67, order-no.: 1688573
- 2 keys for torx socket screws TX20, TX30

1.4.3 Version one Switch LAN Module with two LAN Connections with Cable Screw Cap

- 2 LAN connections internal
- Housing with 1 cable screw caps and 2 bored holes with sealing plugs at the upper side.

Box contents

The scope of the delivery includes:

- Telephone
- Printed short manual
- Manual on CD
- 1 LAN female connector for cable mounting from Tycoelectronics (AMP), order-no. 116604-2
- 2 keys for torx socket screws TX20, TX30

1.4.4 Version one Switch LAN Module with two LAN Connections with Cable Screw Cap

- 1 LAN connection female housing connection
- 1 LAN connection and sealing plug at the housing
- Housing with 1 bored hole with sealing plug at the upper side

Box contents

The scope of the delivery includes:

- Telephone
- Printed short manual
- Manual on CD
- 1 LAN connector from Phoenix Contact, consisting of:
 - o RJ sleeve housing Type VS-08-T-RJ45/IP67, Art.-Nr.: 1688696
 - o Male insert RJ45, CAT5, 8-polig Type VS-08-ST-RJ45/IP67, order-no.: 1688573
- 2 keys for torx socket screws TX20, TX30

1.5 Mounting and Installing

The device must be installed on a plane surface only, in vertical operating position. Loosen the cover screws (2) (see Figure 5 to Figure 7) and detach the upper part of the telephone (1). If the optional accessory headset or a second earpiece is being employed, attach the bracket (10) using two screws (11) to the rear panel of the lower part of the telephone. (With the accessories named before, the bracket and screws are in the scope of delivery. With all accessories a cable gland is delivered.) Put four screws, having a head diameter of 10 to 13 mm into the holes (20) and attach the lower part of the telephone (3) to the wall or to a holder.

Guide the telephone wire through the cable screw cap (4) and place it on the terminals. Only wires having a sheath diameter of 5 to 9 mm should be used because otherwise the IP66 housing protection standard is not guaranteed.

Prior to assembly, check cover seal for tightness. Using the plug connector (7), plug the ribbon cable onto the pin contact strip (8) in the upper part of the housing. Attach the upper part of the telephone and fasten it to the lower part of the telephone with the four cover screws (2). Upon disassembly of optional accessories, suited sealing plugs must be used to close the resulting openings.

In this telephone connected cords may have hazardous voltages.

To ensure that no water gets into the enclosure it is essential that no gaskets are damaged during installation. The ingress of water can cause accessible parts of the telephone to become live.

Installation and connection must be carried out by competent personnel familiar with electrical and network installations.

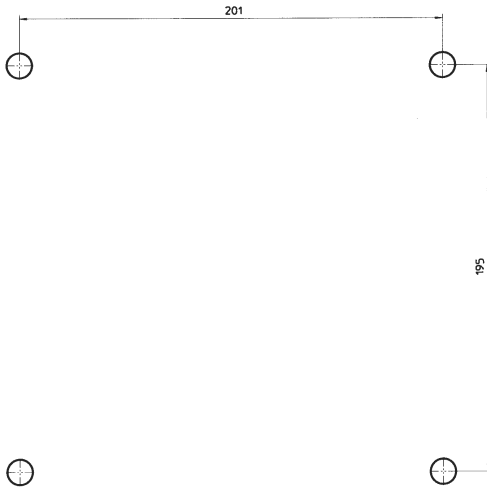

Figure 4: Drilling Diagram Wall Mounting

The diameter of the drilled hole is dependent on the screw employed (screw diameter max. 8 mm) and the type of supporting base material (steel, wood, concrete, plasterboard etc.) and must be chosen accordingly.

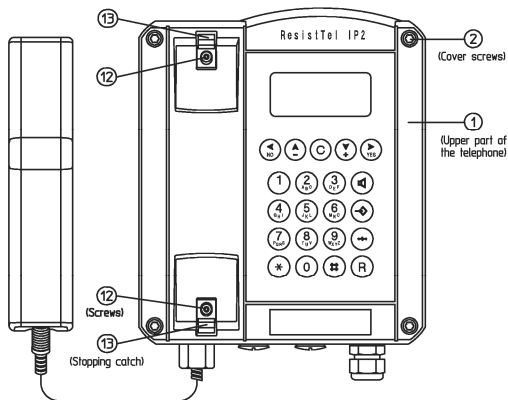

Figure 5: Set View

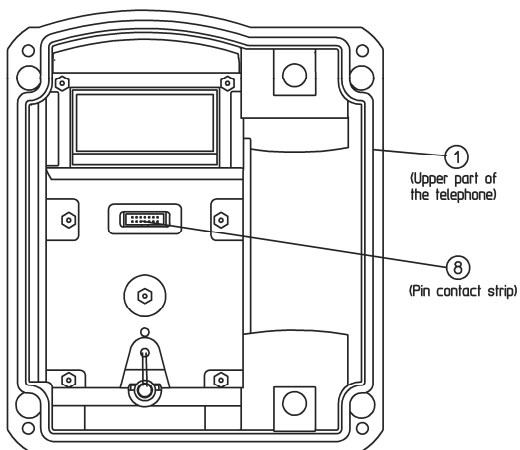

Figure 6: Inside View of Telephone upper Part

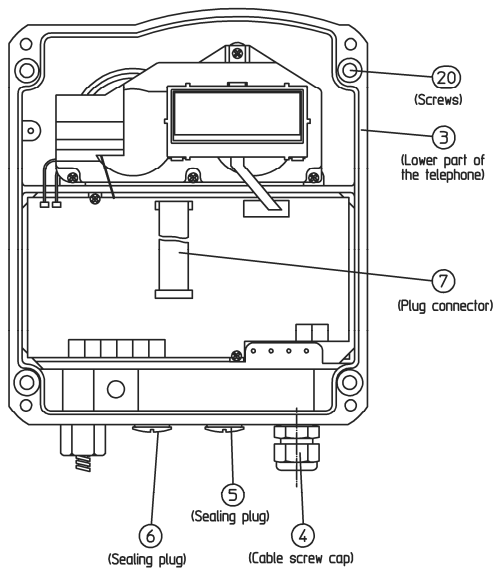

Figure 7: Inside View of Telephone lower Part

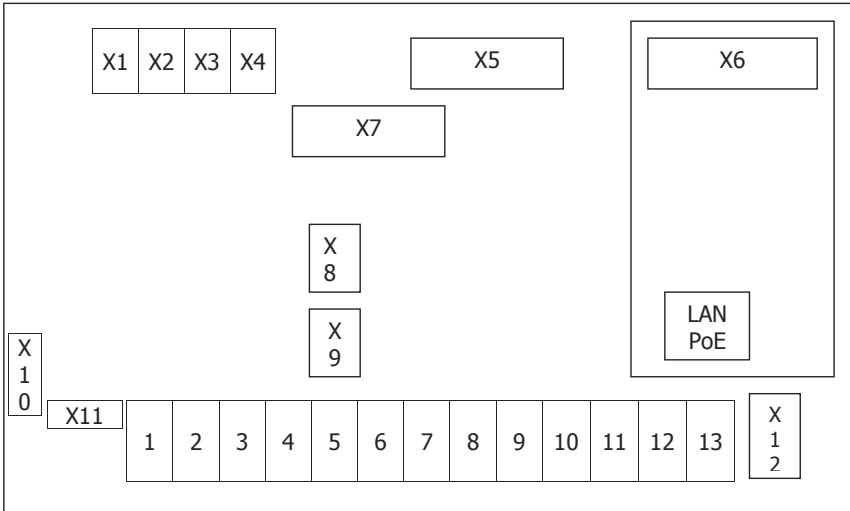

Figure 8: Connection Diagram with Single LAN Module

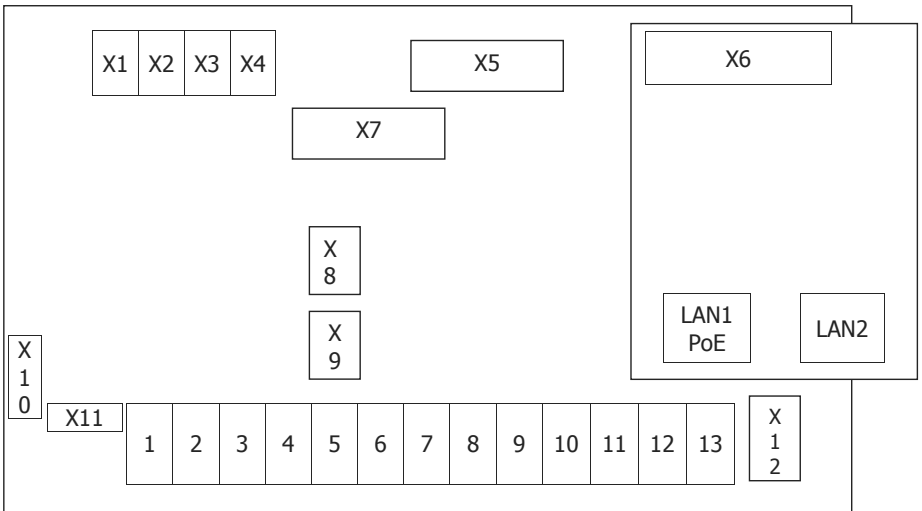

Figure 9: Connection Diagram with Switch LAN Module

Connector	description
X1	Loudspeaker left
X2	Loudspeaker right
X3	Heater of the Display
X4	Illumination of the Display
X5	Display
X6	LAN Module
X7	Keypad
X8	Hookswitch (Reed Contact)
X9	RS232 Module (optional)
X10	Amplifier Module (optional)
X11	Handset
X12	Relay Module (optional)
LAN PoE	LAN with PoE (LAN-Link, single LAN Module)
LAN1 PoE	LAN1 with PoE (LAN-Link, Switch LAN Module)
LAN2 (PC)	LAN2 (PC-Link, Switch LAN Module)
1 - 13	Terminals (Configuration see the following Chapters)

Table 4: Plug in Connectors and Terminals of the ResistTel IP2 / IP152

1.5.1 LAN-Connections

1.5.1.1 Default Version one LAN Connection with a Cable Screw Cap

The telephone has in the default version one internal LAN-connection with a cable screw cap. For the connection a LAN cable must be pulled through the cable screw cap. Inside the phone the female LAN connection from Tycoelectronics (AMP) has to be pressed on the cable (Refer to chapter 1.4 beginning on page 10). A female LAN cable connector belongs to the as-delivered condition. With the inside the phone existing little LAN connection cable, the LAN can be connected with the phone.

The LAN delivery can be available with PoE (Power over Ethernet). Alternatively the phone can be supplied with power external.

All not used cable feed through have to be closed with sealing plugs.

1.5.1.2 Version one LAN Connection with a Female Housing Connection

The phone has in this version one LAN-connection with a female LAN connection at the housing. LAN-cable, used for plug into the telephone ResistTel IP2 / IP152, have to be adapted with a connector from Phoenix contact (Refer to chapter 1.4 beginning on page 10), to preserve the IP66 degree of protection. A LAN cable connector belongs to the as-delivered condition.

The LAN-lead wire has to be connected to the connector in the front. Die LAN lead wire can to be with PoE (Power over Ethernet). Alternatively the phone can be supplied with power external.

The second LAN connector of the ResistTel IP2 / IP152 is a blind connector closed with a protective cap to preserve the IP66 degree of protection

All not used cable feed through have to be closed with sealing plugs.

Caution



You can use PoE (Power over Ethernet) or an external connection to supply the ResistTel IP2 / IP152 with power.

Don't use both at the same time, to prevent damage to the equipment.



1.5.1.3 Version with Switch LAN Module with two LAN Connections with Cable Screw Caps

The telephone has in this version two internal LAN-connections with a cable screw cap. For the connection the LAN cable must be pulled through the cable screw cap. Inside the phone the female LAN connection from Tycoelectronics (AMP) has to be pressed on the cable (Refer to chapter 1.4 beginning on page 10). A female LAN cable connector belongs to the as-delivered condition. With the inside the phone existing little LAN connection cable, the LAN can be connected with the phone.

The LAN1 delivery can be available with PoE (Power over Ethernet). Alternatively the phone can be supplied with power external.

The LAN2 delivery doesn't support PoE. Also it can't be used to connect a phone directly, which should be powered with PoE.

All not used cable feed through have to be closed with sealing plugs.

1.5.1.4 Version with Switch LAN Module with two LAN Connections with two Female Housing Connections

The phone has in this version two LAN-connections with a female LAN connection at the housing. LAN-cable, used for plug into the telephone ResistTel IP2 / IP152, have to be adapted with a connector from Phoenix contact (Refer to chapter 1.4 beginning on page 10), to preserve the IP66 degree of protection. A LAN cable connector belongs to the as-delivered condition.

The LAN-lead wire has to be connected to the connector in the front. Die LAN1 lead wire can to be with PoE (Power over Ethernet). Alternatively the phone can be supplied with power external.

The second LAN connector of the ResistTel IP2 / IP152 doesn't support PoE. Also it can't be used to connect a phone directly, which should be powered with PoE.

All not used cable feed through have to be closed with sealing plugs.

1.5.2 External Power Supply Connection

An external power supply can be adapted to the terminals 5 (+) and 6 (-). The voltage has to be:

- Without using the optional voltaic separated inputs: 15 V – 57 V DC, 13 W
- With using the optional voltaic separated inputs: 21,5 V – 57 V DC, 13 W

If the external power connection will be used, you must not use PoE at the LAN connection.

1.5.3 Relay Connection

The phone can be build up with a relay module with two relays with a single changeover switch optional.

The maximal breaking capacity of a relay is depending on the voltage:

- 240 V, 6 A, AC
- 24 V, 6 A, DC
- 32 V, 5 A, DC
- 48 V, 1 A, DC

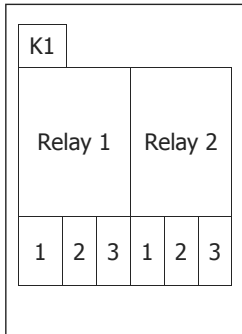

Figure 10: Connection Diagram Relay Module

Connector	Description
K1	Cable to the main board (connection to plug in X12)
1 (relay 1)	Bottom contact relay 1
2 (relay 1)	Middle contact relay 1
3 (relay 1)	Switching contact relay 1
1 (relay 2)	Bottom contact relay 2
2 (relay 2)	Middle contact relay 2
3 (relay 2)	Switching contact relay 2

Table 5: Plug in Connectors and Terminals of the Relay Module

Pay particular attention to the following points if hazardous voltages (>48V) are to be connected to the relay outputs:

- Cable and cords must be insulated and have to be conducted below the cover.
- The circuits that the relay outputs are connected to must be of the same type; i.e. both mains, both SELV or both TNV circuits.
- It is not permissible to connect different types of circuits to these relays.

1.5.4 Other Terminals

The terminals 1 – 4 are for connecting a headset. A detailed description is enclosed in the manual.

The terminals 7 – 13 are reserved for future use and must not be connected.

1.5.5 Sling Holder

The holding strength for the handset is continuously adjustable.

Loosen the screws (12) and move the stopping catches (13) (See Figure 5 – Figure 7 Figure 5: Set View). Pushing the stopping catches together increases the holding strength whereas pulling them apart reduces it. Tighten the screws again.

1.5.6 General

The receiver is equipped with a leakage field spool for coupling of hearing aids. Users of a hearing aid with inductive receiver may receive the signal from the receiver inset directly.

1.6 EMC-Directive

The device complies with the requirements of the new EMC-directive 2004/108/EC, the low voltage directive 2006/95/EC and the R&TTE directive 1999/5/EC.

The conformity with the above directives is confirmed by the CE sign.

2 Operating Manual

2.1 Operating Basics

The keys below the display (⏪ ⏩ ⏴ ⏵ ⏶) of the VoIP telephone ResistTel IP2 / IP152 serve menu navigation and, for edit field input purposes, are assigned an additional function on top of their actual function, as explained below.

Key assignment in menu:

The function is performed by ...
scrolling upwards	Arrow key up ⏴
scrolling downwards	Arrow key down ⏵
one level up without saving	Arrow key left ⏪
one level down	Arrow key right ⏩
one level up with saving	Menu key ⏶
Leave the menu complete immediately	Disconnect key ⏴

Key assignment in edit field:

The function is performed by ...
scrolling right	Arrow key right ⏩
scrolling left	Arrow key left ⏪
Delete character in front of cursor	Clearing key ⏴

Pressing and holding the numeric key, activates the **character mode**. Refer to chapter 2.1.4 Input of Characters and Special Characters beginning on page 23.

The **initial condition** means that the telephone is in the switching state hang up. This state consists if the following conditions are fulfilled:

- The telephone is hanged up or will be hanged off and then the key ⏴ will be pressed.
- The hands free mode isn't active.
- The headset mode isn't active.

2.1.1 Adjusting the Volume

You can adjust the volume while establishing connections as well as during calls. The volume remains on this level after the call. The "Vol." indicator shows the current value (see Figure 11).

You can increase the volume level by pressing the key .

You can reduce the volume level by pressing the key .

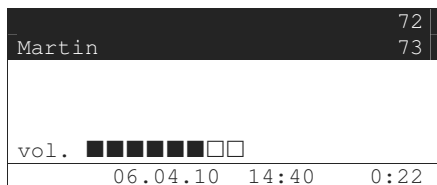



Figure 11: Adjusting the Volume

You control the volume of the active mode.

- At the handset mode you control the volume of the speaker of the handset.
- At the listening mode you control the volume of the additional connected speaker of the phone.
- At the hands free mode you control the volume of the speaker in hands free mode.
- At the headset mode you control the volume of the speaker of the headset.

2.1.2 Do not Disturb

You can turn off the do not disturb function of the VoIP telephone ResistTel IP2 / IP152 simply by pressing a key, for example if you do not wish to be disturbed during a meeting.

1. To activate the do not disturb function; press the key  for about a second whilst in idle mode until the display appears in Figure 12. The telephone reacts to an incoming call depending on how this feature is configured at the time. For further details on how to configure the do not disturb feature (see manual).
2. To deactivate the do not disturb function again; press the key  again for about a second until the signalling in the display is deleted. Afterwards the device will respond to calls in the usual way again.

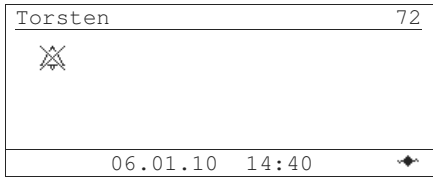

Figure 12: Do not Disturb

2.1.3 Different Types of Call Numbers

In addition to normal call numbers, your IP telephone can also dial H.323 names and IP addresses.

Call numbers consisting of characters other than the digits 0 to 9 and the characters * and # are considered to be H.323 names. Call numbers beginning with the character @ are always regarded as H.323 names. The @ is removed before dialling however.

2.1.4 Input of Characters and Special Characters

You can enter any Western European characters in accordance with ISO 8859-1 using the keypad. The assignment of the characters and special characters to the keys can be seen in Table 6.

The letter mode is activated by pressing the respective key pad for an extended moment of time. Subsequently, it is possible to switch between the letters by pressing the key several times in short intervals or by keeping the key pressed.

key	possible characters and special characters
1	1 + () , - & @ # " * ! \$ % . / : ; < = > ? ' [] \ ^ _ ` { } ~ £ § ¢ ÷
2	2 a b c A B C ä à á â ã ä å æ ç Ä Å Ã Ä Å Æ Ç
3	3 d e f D E F è é ê ë Ë É Ê Ë
4	4 g h i G H I ï ï ï ï Ì Í Î
5	5 j k l J K L
6	6 m n o M N O ö ñ ò ó ô õ ø Ñ Ò Ó Ô Õ
7	7 p q r s P Q R S ß
8	8 t u v T U V ü ú û û Ü Ú Û Ü
9	9 w x y z W X Y Z ý Ÿ ŷ
0	0 (space character)
*	*
#	#

Table 6: Input of Characters and Special Characters

2.2 Operating Modes

The phone ResistTel IP2 / IP152 allows making calls in different operating modes.

1. Handset mode

At handset mode the call will be operated with the handset.

2. Handset mode with open listening

At handset mode with open listening the call will be operated with the handset. The hands free speaker of the phone will be connected additionally. Persons present in the room can listen to the call.

3. Hands free mode

At hands free mode the call will be operated with the hands free microphone and hands free speaker of the phone. All persons present in the room can take part to the call.

If a headset is connected and configured:

4. Headset mode

At headset mode the call will be operated with the headset.

5. Headset mode with open listening

At headset mode with open listening the call will be operated with the headset. The hands free speaker of the phone will be connected additionally. Persons present in the room can listen to the call.

The already active operating mode will be displayed in the state line of the phone.



2.2.1 Changeover from Handset Mode to Handset Mode with Open Listening

To change from handset mode to handset mode with open listening, you have to press the loudspeaker key  during a call.



2.2.2 Changeover from Handset Mode with Open Listening to Handset Mode

To change from handset mode with open listening to handset mode, you have to press the loudspeaker key  during a call.

2.2.3 Changeover from Handset Mode (with or without Open Listening) to Hands Free Mode

To change from handset mode (with or without open listening) to hands free mode, you have to press the loudspeaker key  and hang up the handset with pressed loudspeaker key . Afterwards the loudspeaker key  can be released.



2.2.4 Changeover from Handset Mode (with or without Open Listening) to Headset Mode

To change from handset mode (with or without open listening) to headset mode, you have to press the headset key (Key  long (longer than a second) and then the loudspeaker key ). Afterwards the handset can be hung up.

2.2.5 Changeover from Hands Free Mode to Handset Mode

To change from hands free mode to handset mode, you have to lift off the handset.

2.2.6 Changeover from Hands Free Mode to Headset Mode

To change from hands free mode to headset mode, you have to press the headset key (Key  long (longer than a second) and then the loudspeaker key .

2.2.7 Changeover from Headset Mode to Headset Mode with Open Listening

To change from headset mode to headset mode with open listening, you have to press the loudspeaker key  during a call.

2.2.8 Changeover from Headset Mode with Open Listening to Headset Mode

To change from headset mode with open listening to headset mode, you have to press the loudspeaker key  during a call.

2.2.9 Changeover from Headset Mode (with or without Open Listening) to Handset Mode

To change from headset mode (with or without open listening) to handset mode, you have to lift off the handset.

2.2.10 Other Changeover of the Operating Mode

Other changes of the operating mode can't take place directly. They are only possible with one of the above listed intermediate steps indirect.

2.3 Call Functions

2.3.1 Answering Calls

You receive a call and your phone rings. The name or phone number of the caller is displayed. The name or phone number of the person for whom the call is intended is also displayed. This is particularly useful in the event of multiple registrations on your telephone in order to identify the actual caller when a call is diverted to your telephone.

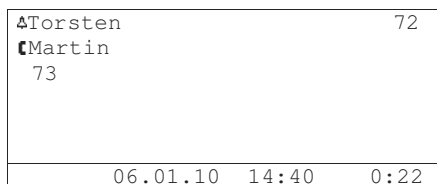





Figure 13: Answering a Call

Answering or rejecting calls:

If you would like to answer the call, you have different possibilities:





- Lift the handset.
- Press the loudspeaker key .
- Press the headset key (Key  long (longer than a second) and then the loudspeaker key .

You will be connected to the caller.

To reject the call, press the key . The phone returns to the idle state and the caller will hear an engaged tone.

2.3.2 Terminating a Call

To finish a call respectively to the active operating mode:

- Put the handset back on its rest
- Press the key .
- Press the loudspeaker key .
- Press the headset key (Key  long (longer than a second) and then the loudspeaker key .

2.3.3 Making Calls

To call someone, you can use single or block dialling.

2.3.3.1 Single Dialling

For single dialling take the following steps:

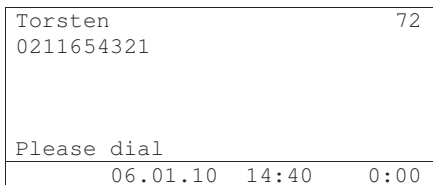









Figure 14: Direct Dialling











1. Respectively to the wanted calling mode:
 - Pick up the handset (handset mode).
 - Press the loudspeaker key  (hands free mode).
 - Press the headset key (Key  long (longer than a second) and then the loudspeaker key  (headset mode).
2. Enter the phone number. In this case the VoIP telephone dials the number while it is being entered.

3. To finish a call respectively to the active operating mode:

- Put the handset back on its rest (handset mode).
- Press the key  (All modes).
- Press the loudspeaker key  (hands free mode).
- Press the headset key (Key  long (longer than a second) and then the loudspeaker key  (headset mode).

2.3.3.2 Block Dialling

For block dialling do the following steps:

1. Let the handset on its rest and don't activate the hands free or headset mode.
2. Enter the phone number completely.
3. When entering the telephone number, you may edit already entered digits. Use the  and  keys to move the cursor, and the key  to delete the digit to the left of the cursor.
4. Respectively to the wanted calling mode, you can setup the call as follows. In this matter, it will be dialled after one of the following activities.
 - a. Lift off the handset (handset mode).
 - b. Press the loudspeaker key  (hands free mode).
 - c. Press the headset key (Key  long (longer than a second) and then the loudspeaker key  (headset mode).
 - d. Press the key  or key  (short or long). With a configured headset you will reach the headset mode otherwise the hands free mode.
 - e. Using the key  (short or long) executes the selection immediately. Using the key , however, executes the selection only if the cursor is situated to the right of the last entered digit.
5. When using block dialling, you may enter further properties of the selection. Do so by pressing the  key. See chapter 2.3.3.2.1 on page 29.

2.3.3.2.1 Menu Parameter Input Indirect Dialling

The following is displayed:

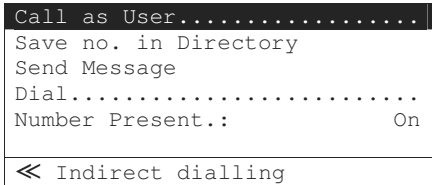

Figure 15: Menu Parameter Input Indirect Dialling

- If you use the cursor keys to select the menu item Call as User and then press the key \odot , the menu User List appears (see manual). Now the User can be changed prior to dialling. The change affects the current call only.
- If you use the cursor keys to select the menu item Save no. in Directory and then press the key \odot , the menu Directory Input appears (see manual). Here the entry may be edited and used in the telephone book.
- If you use the cursor keys to select the menu item Dial and then press the key \odot , the current telephone number is dialled immediately.
- If you use the cursor keys to select the menu item Number Present. and then press the key \odot , the number presentation is switched. The change affects the current call only.
- If you press the key \textcircled{R} (long), the current telephone number is dialled immediately, regardless of the menu item currently selected.
- With Number Presentation On/Off you can select, whether the own calling number or name will be displayed at the called subscriber.

2.3.3.3 Dialling during existing Connections

During existing connections all entered digits (0 – 9, *, #) are transmitted as DTMF signals. Using this DTMF procedure it is possible to access menu-controlled services (e. g. answering machines, voice boxes) directly via the telephone keypad.

2.3.4 Redialling

Up to 100 of the last numbers dialled are saved automatically, together with the time and date, and can be dialled again.

01	06.02.10	11:30	
Martin 73			
02	06.02.10	11:30	↩
Thomas 70			
03	06.03.10	11:29	↩
Peter 36			
< Calls (outbound)			

Figure 16: List of Recently Dialed Numbers and Sent Messages

Dialling numbers from the redial list

1. In the initial condition, press the key $\text{\textcircled{R}}$ (long). The list of numbers dialled last is displayed (see Figure 16).
 - Success (connected/not connected).
The symbol $\text{\textcircled{M}}$ on the display indicates that there has been a successful call. A not connected call will be displayed without a symbol.
 - The symbol $\text{\textcircled{H}}$ on the display indicates that there has been a redirected call.
 - The symbol $\text{\textcircled{T}}$ on the display indicates that there has been a transferred call.
 - The symbol $\text{\textcircled{L}}$ on the display indicates that there has been a dialled number on a locked telephone.
 - The symbol $\text{\textcircled{A}}$ on the display indicates that there has been an automatic call.
 - The symbol $\text{\textcircled{S}}$ on the display indicates that there has been a message sent.
2. Use the arrow keys to select the desired entry.
3. Respectively to the wanted calling mode, you can setup the call as follows:
 - a. Lift off the handset (handset mode).
 - b. Press the loudspeaker key $\text{\textcircled{L}}$ (hands free mode).
 - c. Press the headset key (Key $\text{\textcircled{H}}$ long (longer than a second) and then the loudspeaker key $\text{\textcircled{L}}$) (headset mode).
 - d. Press key $\text{\textcircled{R}}$ (short or long) or the key $\text{\textcircled{H}}$. With a configured headset you will reach the headset mode otherwise the hands free mode.

2.3.5 Call Back

Up to 100 of the last incoming calls are saved automatically, together with the time and date, and can be called back, if the number of the caller was transmitted.

01	06.02.10	11:30	
Martin 73			
02	06.02.10	11:30	↩
Thomas 70			
03	06.03.10	11:29	↩
Peter 36			
> Calls (inbound)			

Figure 17: List of the Last Incoming Calls and Received Messages

Dialling numbers from the calling list

- In the initial condition, press the key $\text{\textcircled{R}}$ (short). The list of the last incoming calls is displayed (see Figure 17).
 - Success (connected/not connected).
The symbol $\text{\textcircled{I}}$ on the display indicates that there has been a call.
 - The symbol $\text{\textcircled{H}}$ on the display indicates that there has been a redirected call.
 - The symbol $\text{\textcircled{+}}$ on the display indicates that there has been a transferred call.
 - The symbol $\text{\textcircled{L}}$ on the display indicates that there has been a dialled number on a locked telephone.
 - The symbol $\text{\textcircled{A}}$ on the display indicates that there has been an automatic call.
 - The symbol $\text{\textcircled{M}}$ on the display indicates that there has been a message received.
- Use the arrow keys to select the desired entry.
- Respectively to the wanted calling mode, you can setup the call as follows:
 - Lift off the handset (handset mode).
 - Press the loudspeaker key $\text{\textcircled{L}}$ (hands free mode).
 - Press the headset key (Key $\text{\textcircled{H}}$ long (longer than a second) and then the loudspeaker key $\text{\textcircled{L}}$) (headset mode).

- d. Press key Ⓜ (short or long) or the key Ⓜ . With a configured headset you will reach the headset mode otherwise the hands free mode.

2.3.6 Muting

You can mute the microphone during a call to make a confidential enquiry in the room without being heard on the phone.

Torsten	72
Thomas	77
🔇	06.01.10 14:40 0:22

Figure 18: Muting

1. Press the key Ⓜ during a call for more than a second. The microphone symbol "🔇" flashes (see Figure 18). The microphone is switched off. You can now make a room enquiry.
2. Press the Mute key Ⓜ during a call for more than a second again. The flashing microphone symbol 🔇 disappears and the microphone is switched on again.

2.3.7 Making second Call

The line can be put on hold during a call. With the call on hold, you can make a second call to someone else. The person on hold can't hear the second call. The hold function is also needed to switch or transfer a call.



Torsten	72
🔇 Peter	36
Torsten	72
Please dial	
📞	06.01.10 14:40 0:22

Figure 19: Holding a Call

1. Press the key Ⓜ (short) during a call. The call is put on hold. you hear a dial tone. The line on hold is displayed normally, the active line inversely (see Figure 19).
2. Dial the call number. A further connection is established.

- To terminate the enquiry call, press the key . You return to the conversation partner previously put on hold.

Tip

The call with the conversation partner highlighted on the display (active) is terminated by pressing the key . If you alternatively want to terminate a call with another conversation partner, first select the respective conversation partner whose connection you want to disconnect using the arrow keys and only then press the key .

2.3.8 Switching

You can switch between two connections using the switch function.







Torsten	72
Peter	36
Torsten	72
 Thomas	70
 06.01.10 14:40 0:22	

Figure 20: Switching

- Press the key  (short) two times or the key  (short) followed by the key  during a call with an active line and a line on hold. The active line is put on hold and the line on hold is activated (see Figure 20).
- To terminate the active line, you must press the key . The connection to the active conversation partner is terminated.







Please note also the tip in chapter 2.3.7 "Making second Call" beginning on page 32.

2.3.9 Transferring a Call

You are making a call and would like to transfer it to another party.

Torsten	72
Peter	36
Torsten	72
🔊 Thomas	70
📶	06.01.10 14:40 0:22

Figure 21: Transferring a Call

1. Press the key  (short) during a call.
The call is put on hold. You hear a dial tone. The line on hold is displayed normally and the active line inversely.
2. Dial the call number of your choice.
The connection is established. If the called party answers, this can be treated like a second call, as above.
3. To connect the caller will be connected with the dialled number you have the following possibilities:
 - a. Put the handset back on its rest (handset mode).
 - b. Press the loudspeaker key  (hands free mode).
 - c. Press the headset key (Key  long (longer than a second) and then the loudspeaker key  (headset mode).
 - d. Press the key  (short) followed by the key . The caller will be connected with the dialled number.

Tip

When transferring a call, you do not have to wait until the desired subscriber answers. You can hang up immediately after dialling the phone number.

2.3.10 Transferring a Call directly

You are making a call and want to switch it to another connection.

Torsten	72
Peter	36
Transfer	

Figure 22: Transferring a Call Directly

1. Press the key $\text{\textcircled{R}}$ (long) during a call.
2. You will be left. The actual connection will not be displayed.
3. Dial the call number of your choice.
4. Press the key $\text{\textcircled{R}}$ (short) or key $\text{\textcircled{D}}$.
5. The caller will be connected with the dialled port directly.
6. With handset mode hang up.









2.3.11 Initiating a Conference

You can use this function to set up a conference between two lines. To do so, you need an active line and a line on hold (refer to chapter 2.3.7 "Making second Call" beginning on page 32).

Torsten	72
anonym	
Torsten	72
$\text{\textcircled{M}}$ Peter	36
3party	
$\text{\textcircled{M}}$	06.01.10 14:40 0:22



Figure 23: Conference

1. Press the key $\text{\textcircled{D}}$ or the key $\text{\textcircled{R}}$ (short) followed by the key $\text{\textcircled{3}}$ during a call with an active line and a line on hold.
A conference is set up between the active line and the line on hold. All the subscribers can now talk with each other (see Figure 23).

2. You can end the conference by pressing the key  respective the key  (short) followed by the key  or twice the key  (short). If you end the conference with pressing the key  or the key  (short) followed by the key , the call put on hold prior to the initiated conference is now on hold again and the previously active call is active once again. If you end the conference with pressing the key  (short) twice, the call put on hold prior to the initiated conference is now active and the previously active call is now on hold.
3. To terminate the active line, you must press the key . The connection to the active conversation partner is terminated. Please note also the tip in chapter 2.3.7.

Note

If you

- hang up (handset mode)
- press the loudspeaker key (hands free mode)
- press the headset key (Key  long (longer than a second) and then the loudspeaker key  (headset mode)

during the conference, the lines of both parties keep connected.

3 Technical Data weatherproof Telephones

Connection data	
Power supply	Power over Ethernet refer to IEEE 802.3af or external power supply
Voltage PoE	48V DC (Min. 44V, Max. 57V)
PoE	Class 0
Voltage external power supply without using the optional voltaic separated inputs	15 V – 57 V DC
Voltage external power supply for using the optional voltaic separated inputs	21.5 V – 57 V DC
Power	12.95 W
Breaking capacity relay (optional)	240 V, 6 A, AC 24 V, 6 A, DC 32 V, 5 A, DC 48 V, 1 A, DC
Connection	RJ45 Port (10/100 Mbit/s)
Ringng volume	Max. 98 dB(A) in 1 m distance
Housing (Height x Width x Depth) without cable screw caps	267 x 225 x 132 mm
Weight (default version)	ca. 5.0 kg
Display	<ul style="list-style-type: none"> • 182 x 64 pixel • Field of view ca. 78 mm x 26 mm
Keypad	<ul style="list-style-type: none"> • Metal keypad with ice protection • 21 keys with ABC marking
Hook switch	Reed contact without mechanical switch
Operating utilization position	Vertical wall mounting
Handset	
Mouthpiece	Electret-foil microphone
Receiver inset	Dynamic receiver inset with magnetic field generator
Sling holder	Integrated adjustable sling holder
Handset cable	Armed court

Environmental conditions	
Ambient operating temperature	-40°C...+70°C
Transport and storage temperature	-40°C...+80°C
Conformities	
Degree of protection	IP66 acc. to IEC 60529
Degree of protection against external mechanical impacts	IK09 acc. to EN IEC 62262
Declaration of Conformity	Directive 1999/5/EU (R&TTE) Directive 2004/108/EG (EMC) Directive 2006/95/EG (low voltage)
Restriction of Hazardous Substances (ROHS)	Directive 2011/65/EG
Waste Electrical and Electronic Equipment (WEEE)	Directive 2012/19/EG EAR registration no.: DE 58023377
User interface	
Web-interface (administration)	English
Telephone (user menu)	16 languages adjustable

4 Notes

Subject to alterations
or errors



FHF Funke + Huster Fernsig GmbH

Gewerbeallee 15-19 · D-45478 Mülheim an der Ruhr
Phone +49/208/82 68-0 · Fax +49/208/82 68-286
<http://www.fhf.de> · e-mail: info@fhf.de